



Objetivo

El estudiante identificará las letras del alfabeto.



Materiales

- ▶ Tarjetas de letras en mayúsculas y minúsculas.
Elige de ocho a diez pares de letras en mayúsculas y minúsculas.



Actividad

Los estudiantes emparejan letras mayúsculas y minúsculas mientras juegan a un juego de memoria.

1. Separa las tarjetas de letras mayúsculas y minúsculas. Coloca las tarjetas boca abajo en diferentes filas.
2. Por turnos, los estudiantes seleccionan dos tarjetas y nombran la letra de cada una (por ejemplo, "H, h" o "b, Q").
3. Determina si hay una coincidencia de letras. Si hay una coincidencia (por ejemplo, H, h), recoge las tarjetas, colócalas a un lado y toma otro turno. Si las tarjetas no coinciden (por ejemplo, b, Q), devuélvelas a sus posiciones originales y permite que tu compañero tome un turno.
4. Continúa hasta que se emparejen todas las cartas de letras.
5. Evaluación por pares

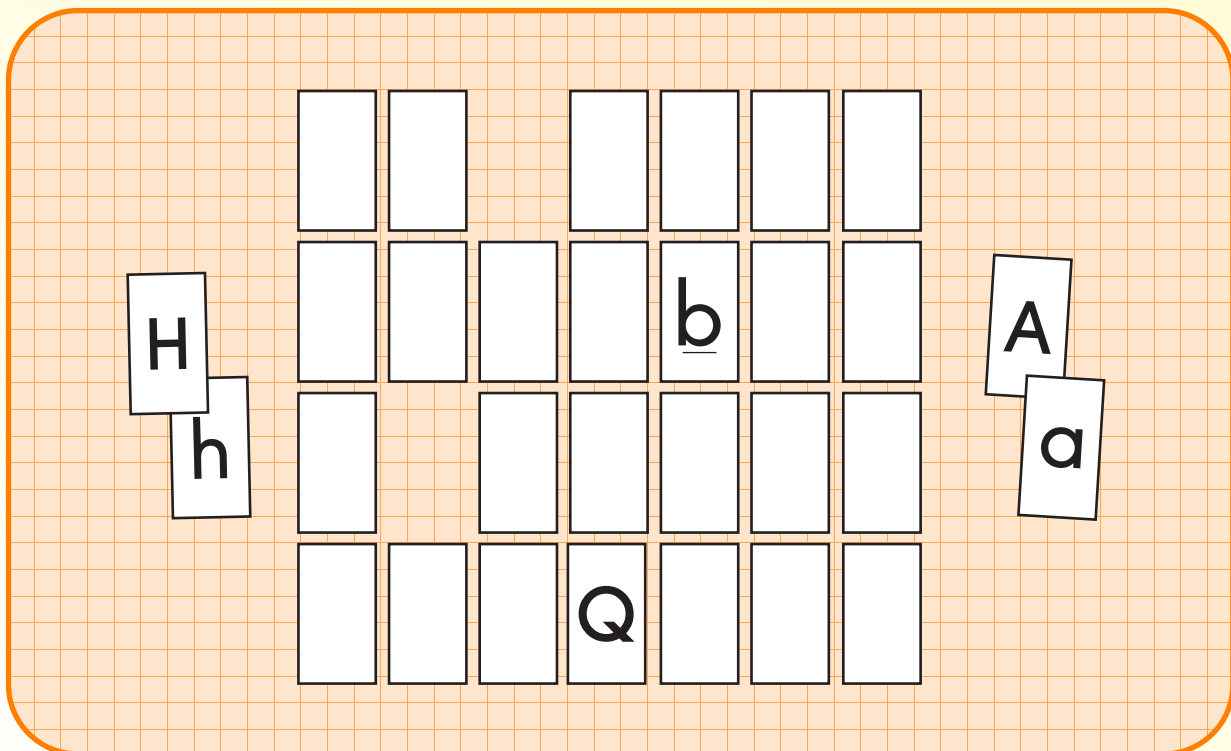

Extensiones y Adaptaciones

- ▶ Jugar usando otras letras objetivo.
- ▶ Hacer coincidir letras con tarjetas de imágenes de sonidos iniciales.

Fónica

Juego de Memoria del Alfabeto

P.008es

A

B

C

D

E

F

G

H

I

tarjetas de letras



J

K

L

M

N

Ñ

O

P

Q



Fónica

Juego de Memoria del Alfabeto

P.008es

R

S

T

U

V

W

X

Y

Z

tarjetas de letras



a

b

c

d

e

f

g

h

i



Fónica

Juego de Memoria del Alfabeto

P.008es

j

k

l

m

n

ñ

o

p

q

tarjetas de letras



r

s

t

u

v

w

x

y

z



Fónica

Juego de Memoria del Alfabeto

P.008es

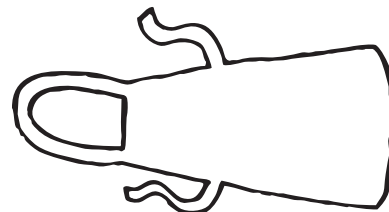
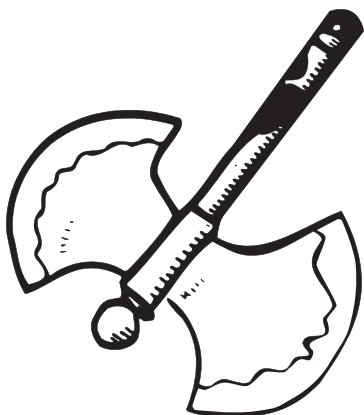
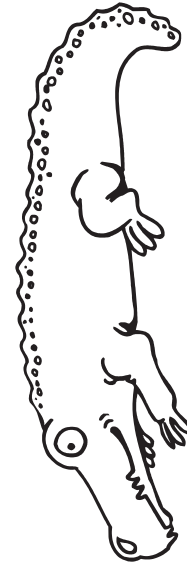
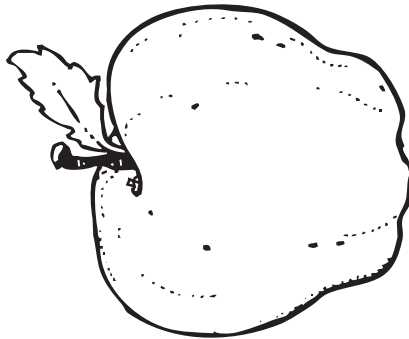
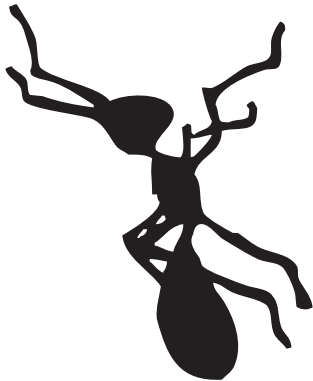

hormiga, manzana, caimán, hacha, mono, delantal

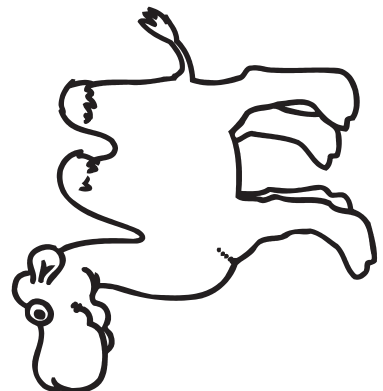
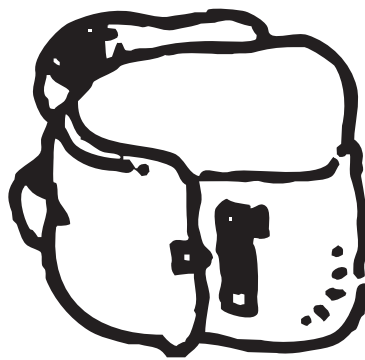
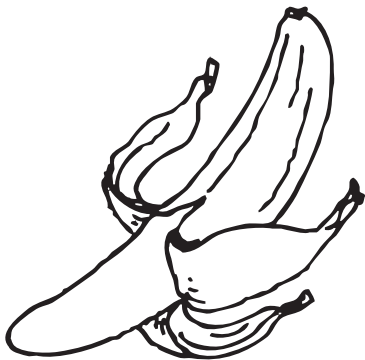
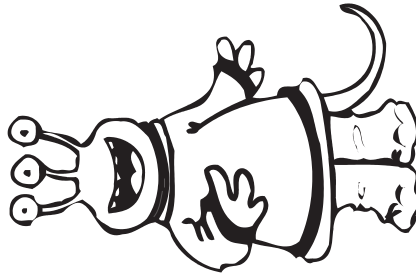
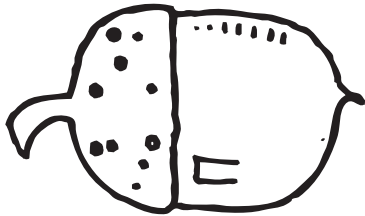

bellota, extraterrestre, playa, plátano, mochila, camello

Fónica

Juego de Memoria del Alfabeto

P.008es

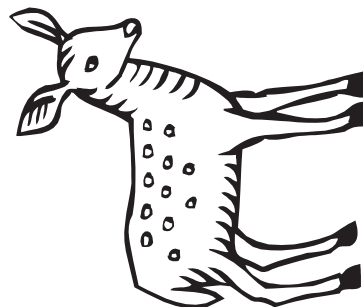
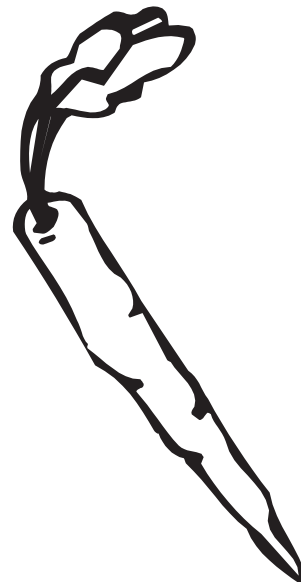
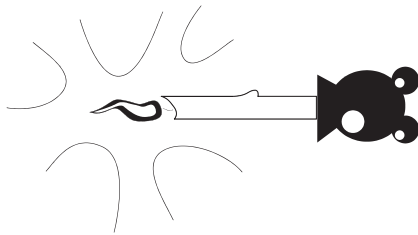

bastón, vela, zanahoria, rosquilla, dragón, ciervo



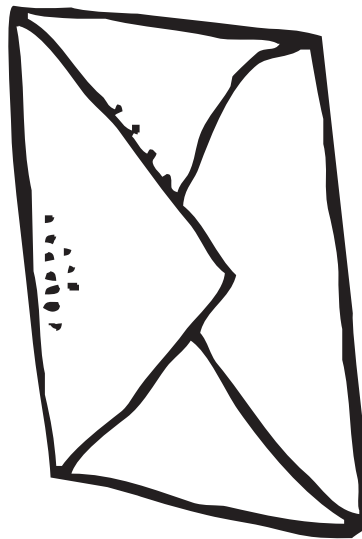
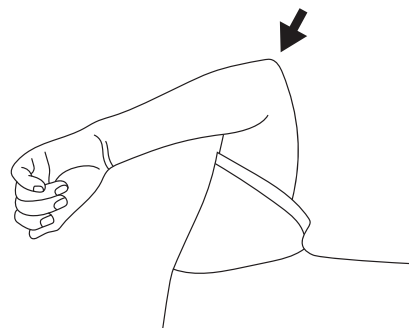
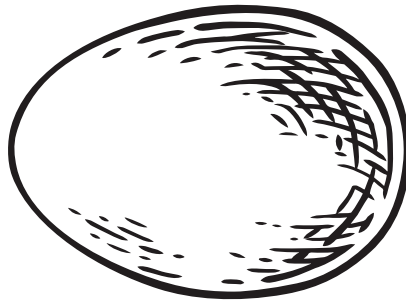
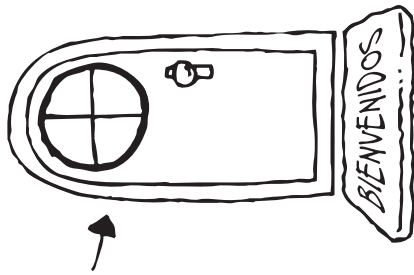

$$2 + 2 = 4$$

An arrow points to the equals sign in the equation.

puerta, huevo, duende, codo, sobre, igual



Fónica

Juego de Memoria del Alfabeto

P.008es

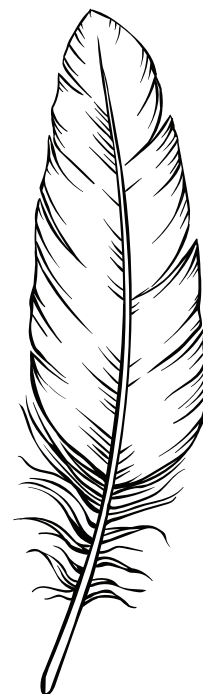
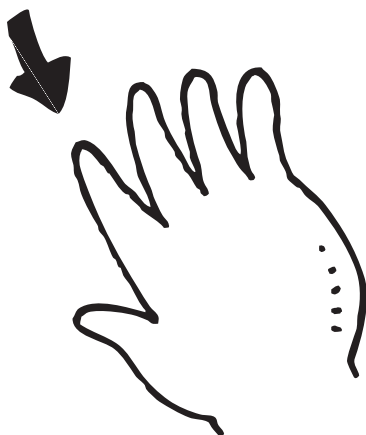
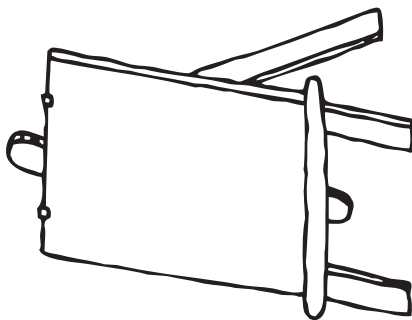

águila, caballete, comer, cuatro, dedo, pluma



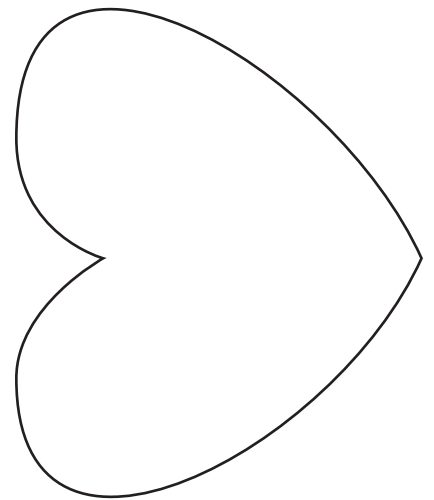
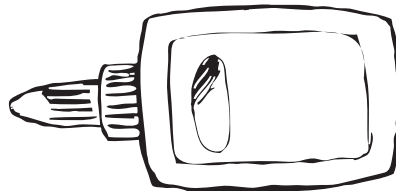
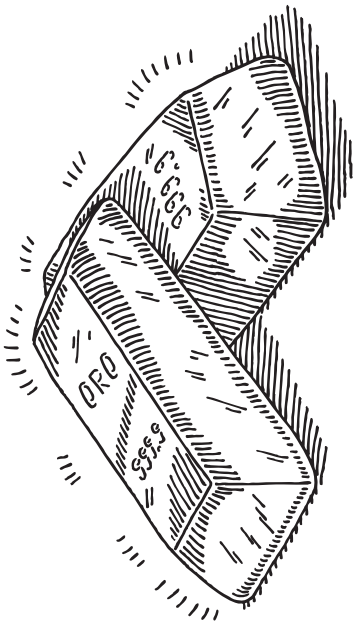
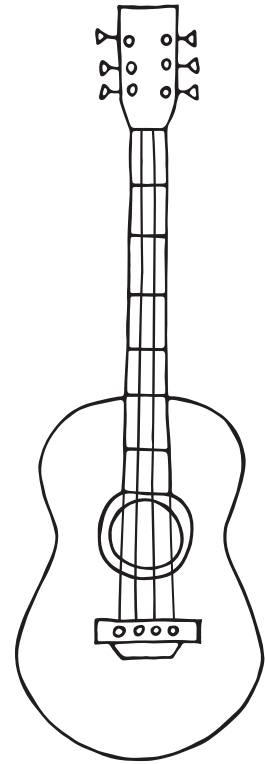
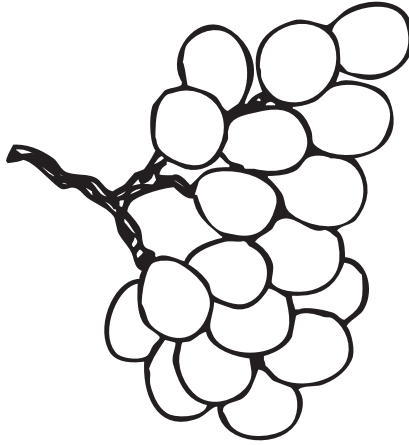
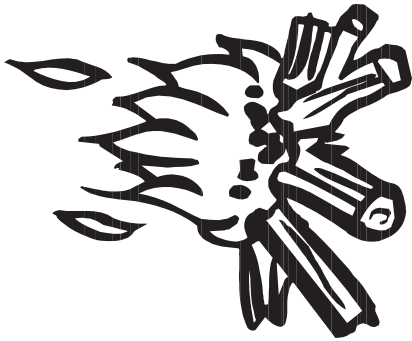

fuego, uvas, guitarra, oro, pegamento, corazón



Fónica

Juego de Memoria del Alfabeto

P.008es

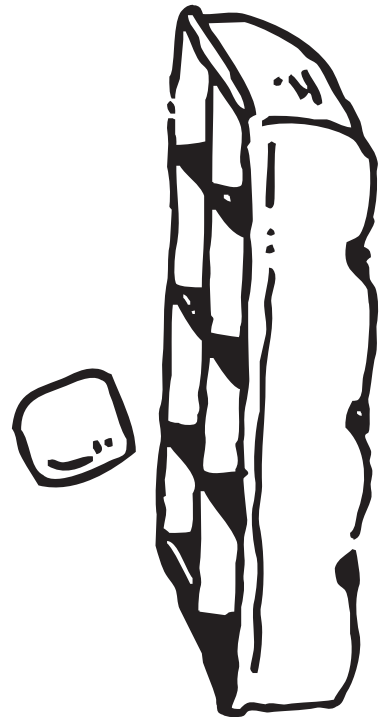
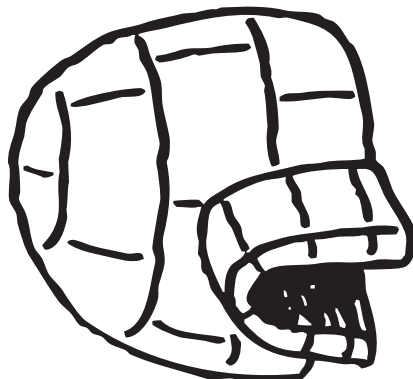
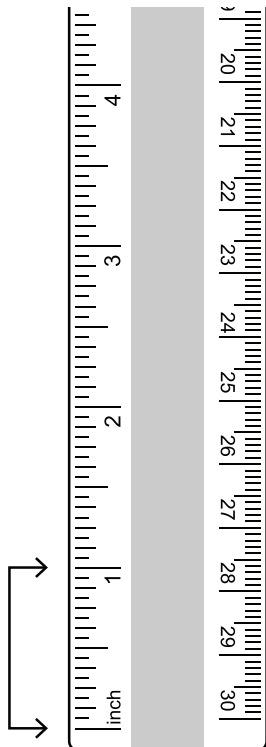
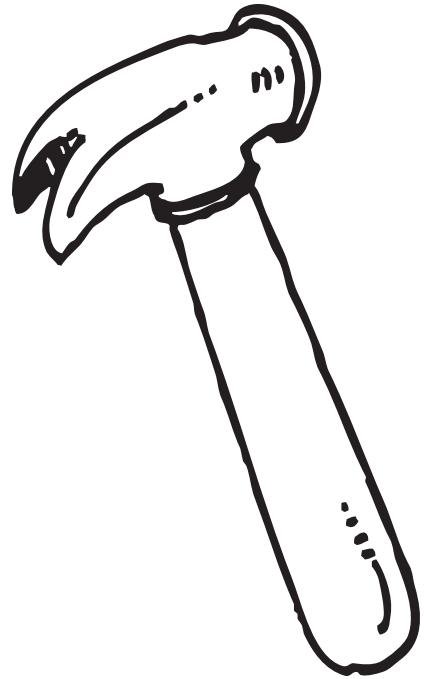
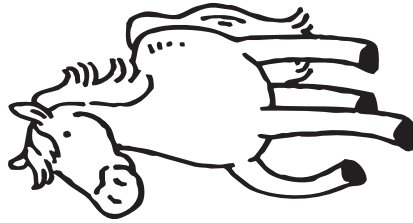
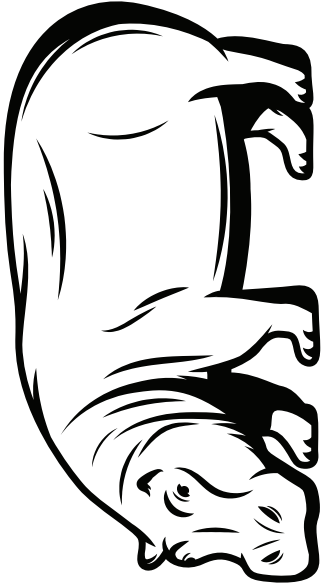

hipopótamo, caballo, martillo, pulgada, iglú, hielo



P.008es

Juego de Memoria del Alfabeto

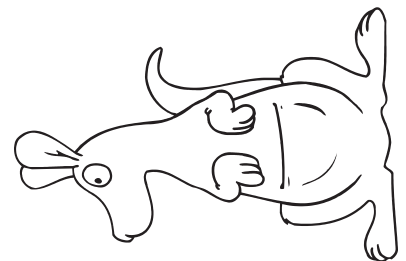
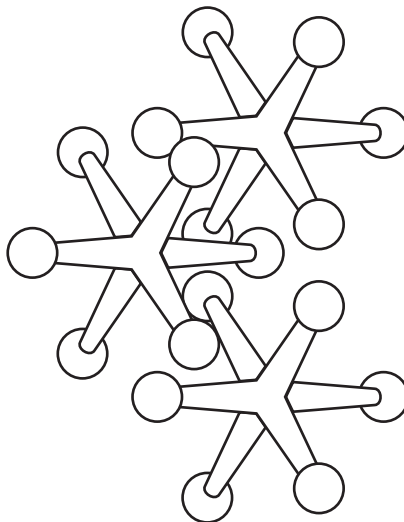
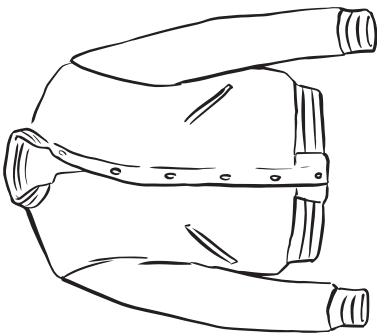
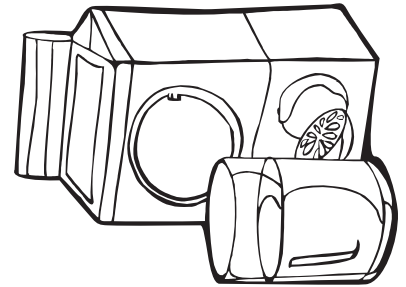
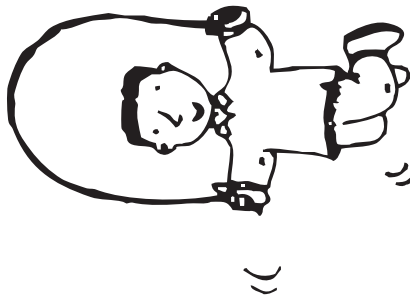
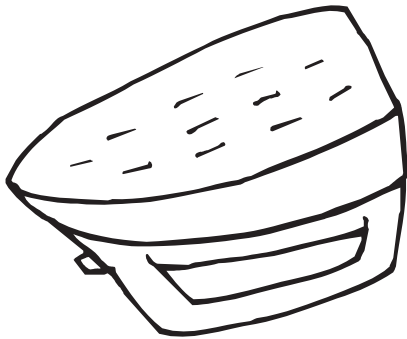

hierro, salto, jugo, chaqueta, gatos (*también conocido como jax), canguro



Fónica

Juego de Memoria del Alfabeto

P.008es

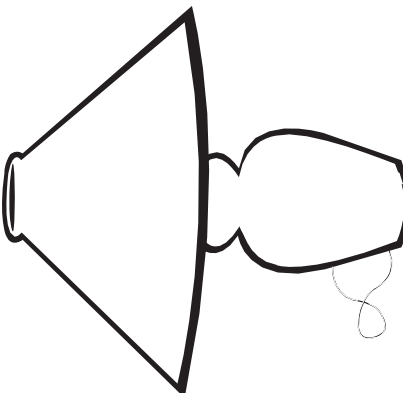
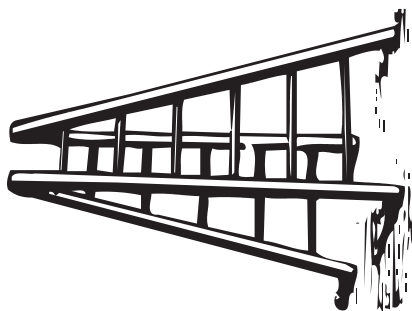
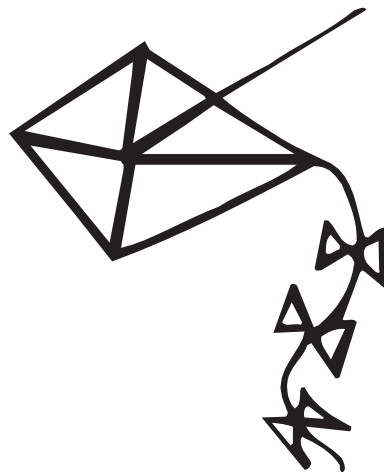
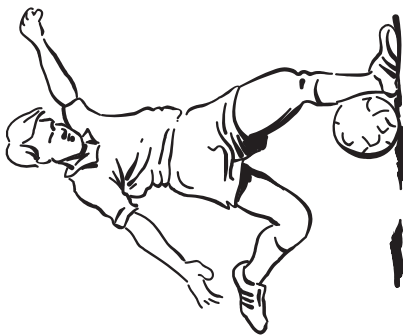

llave, patada, cometa, escalera, lámpara, león



P.008es

Juego de Memoria del Alfabeto

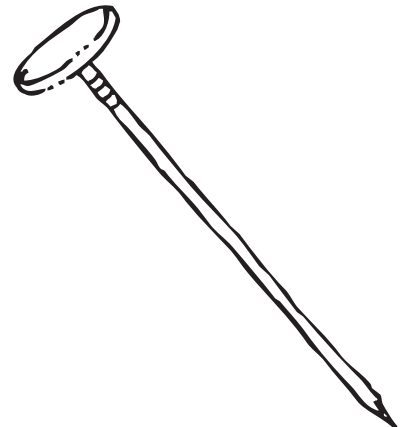
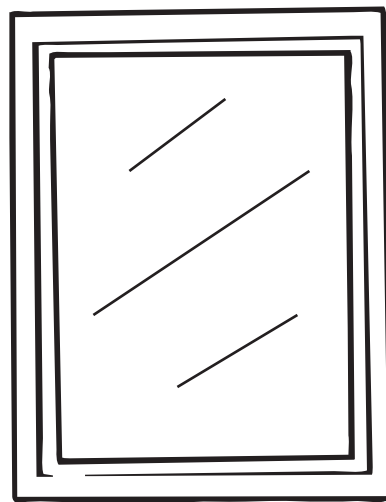
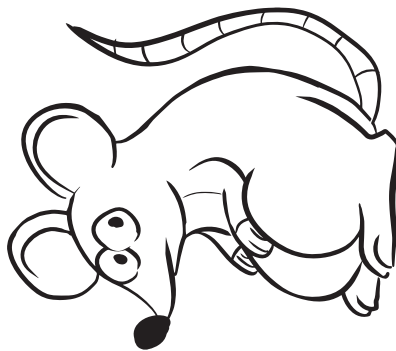
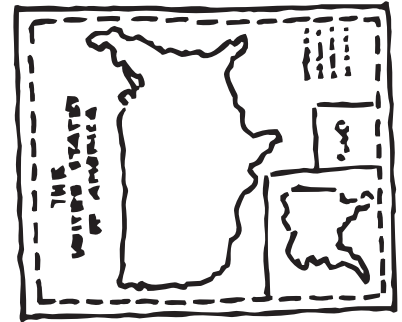
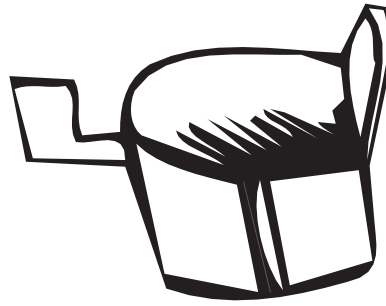
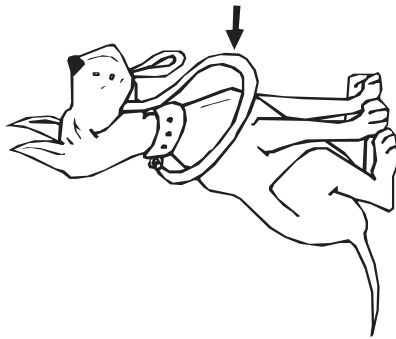

correa, buzón, mapa, ratón, espejo, clavo



Fónica

Juego de Memoria del Alfabeto

P.008es

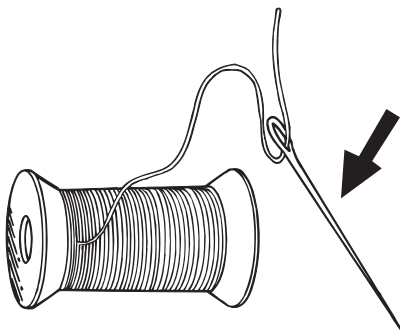
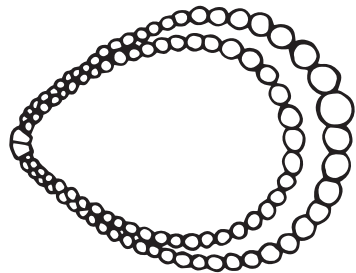

collar, aguja, enfermera, pulpo, buey, aceituna



P.008es

Juego de Memoria del Alfabeto

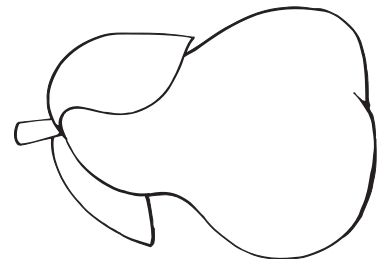
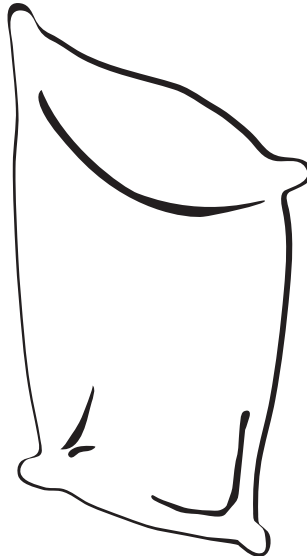
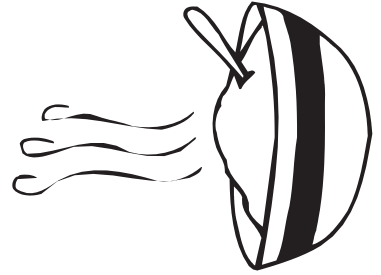
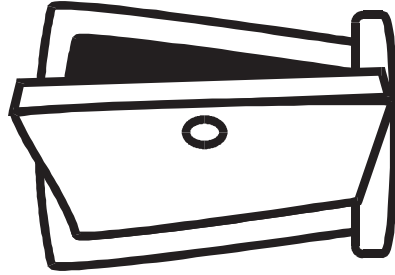

avestruz, abierto, avena, galleta salada (*pretzel), almohada, pera



Fónica

Juego de Memoria del Alfabeto

P.008es

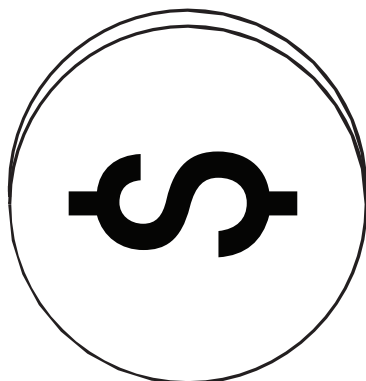
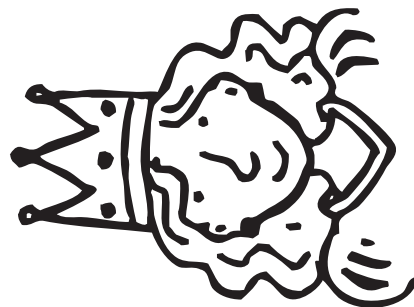
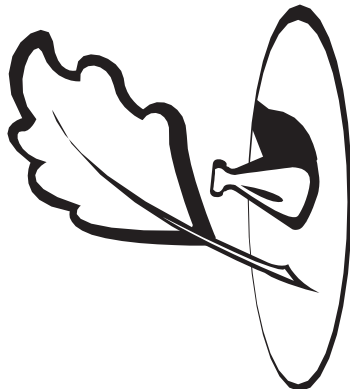
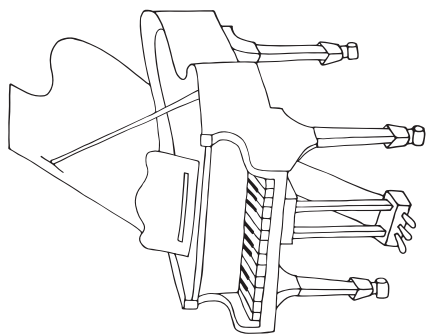

piano, pluma, reina, pregunta, moneda, conejo



P.008es

Juego de Memoria del Alfabeto

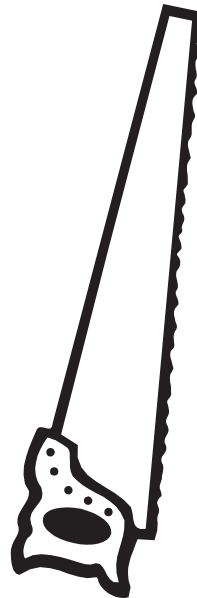
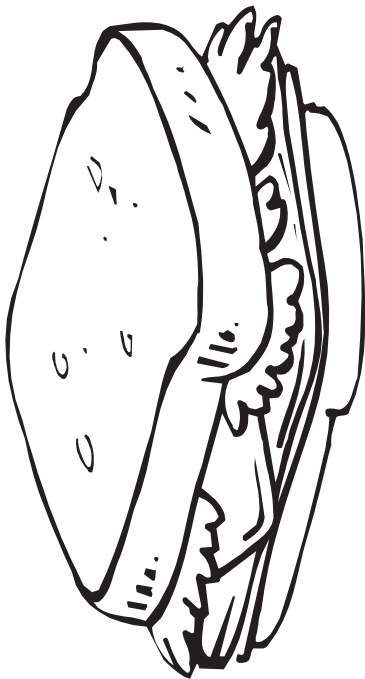
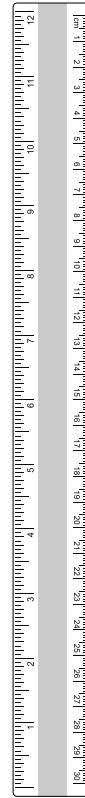
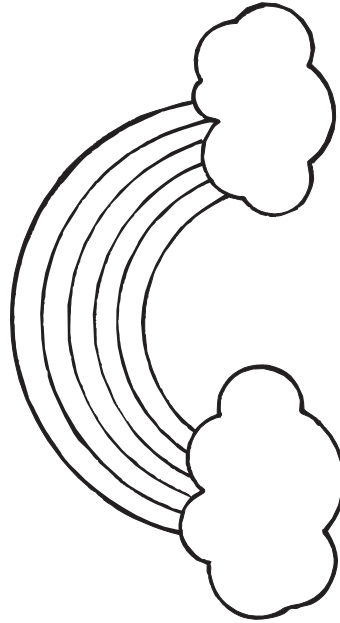
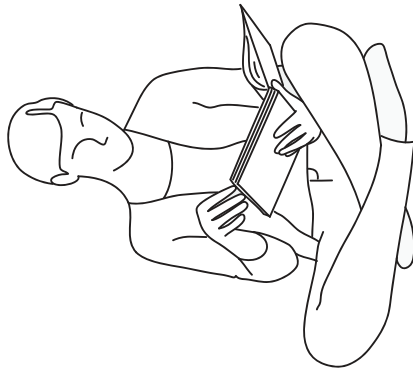

leer, arcoíris, regla, sándwich, sierra, siete

Fónica

Juego de Memoria del Alfabeto

P.008es

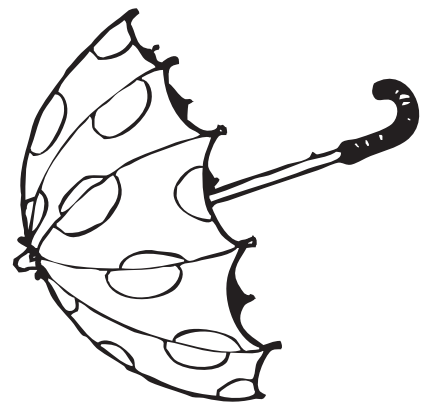
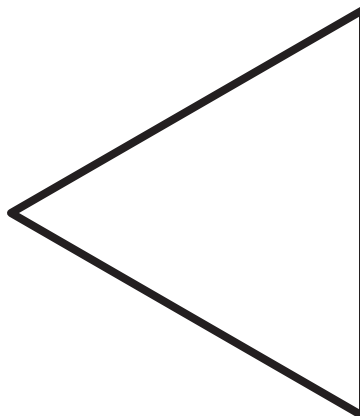
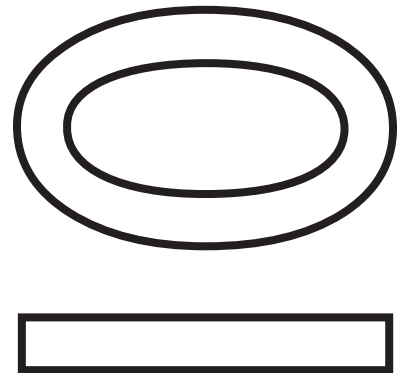
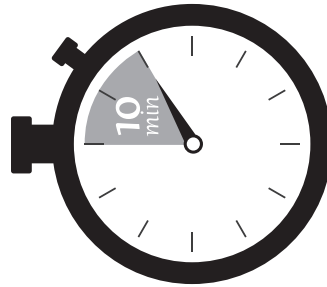

serpiente, temporizador, diez, neumático, triángulo, paraguas



P.008es

Juego de Memoria del Alfabeto

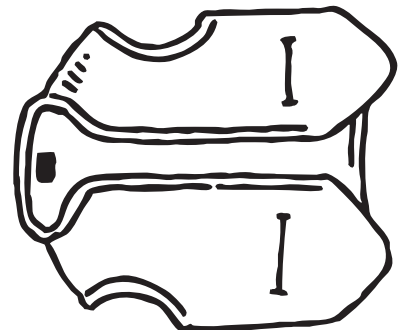
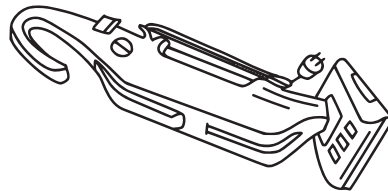
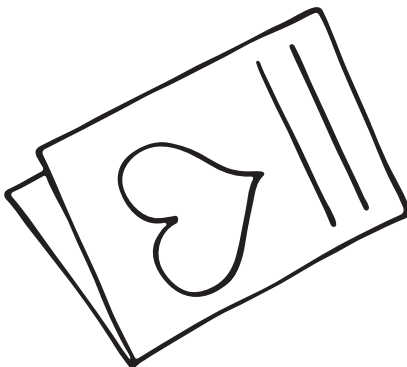
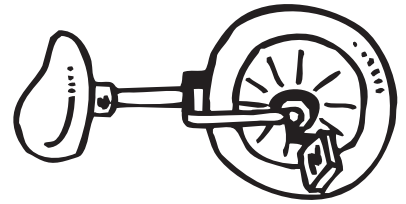
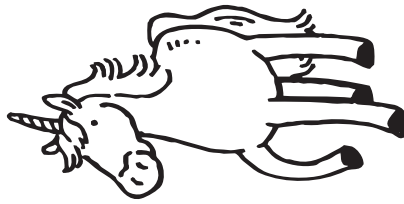

árbitro, unicornio, monociclo, San Valentín, aspiradora, chaleco



Fónica

Juego de Memoria del Alfabeto

P.008es

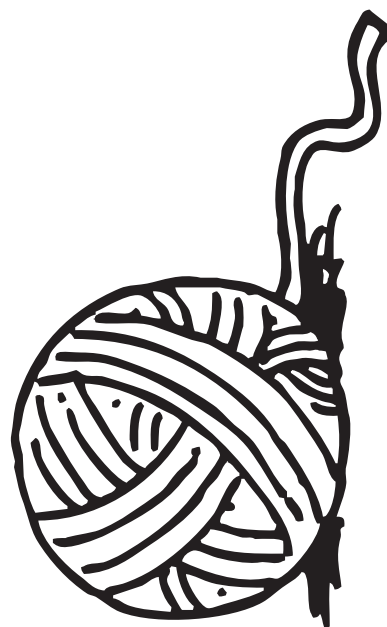
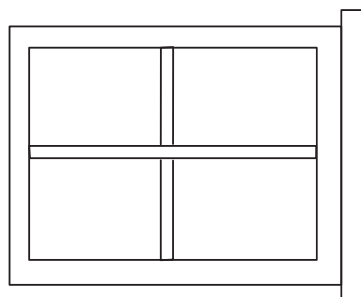
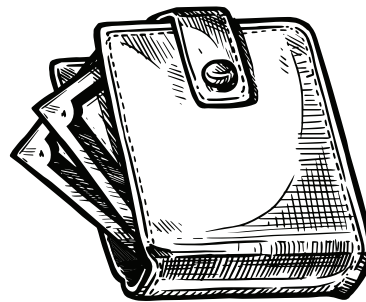
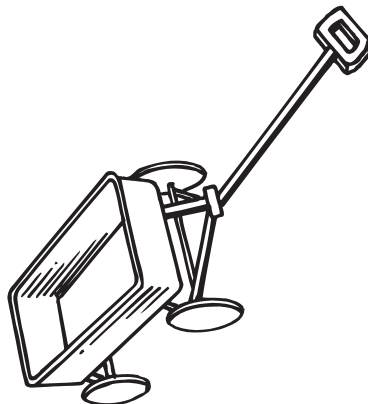
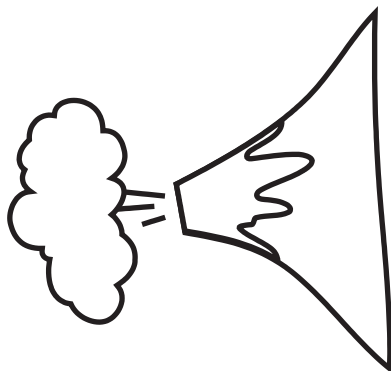

volcán, carro, billetera, reloj, ventana, hilo



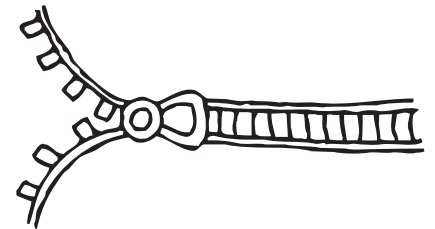
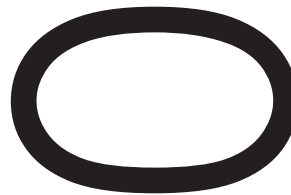
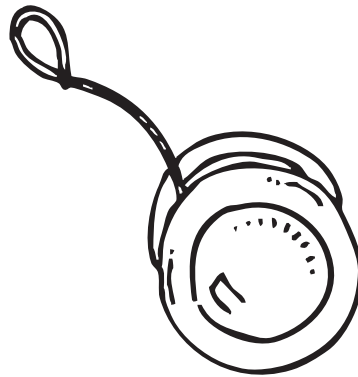

bostezo, yoyó, yak, cebra, cero, cremallera



Fónica

Juego de Memoria del Alfabeto

P.008es

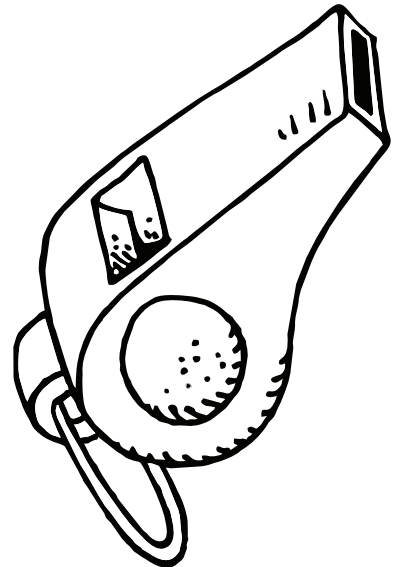
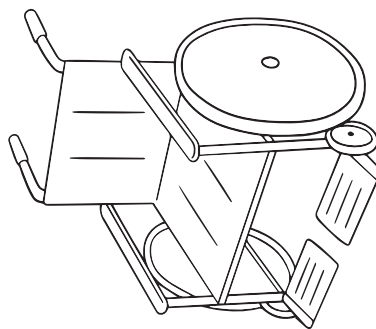
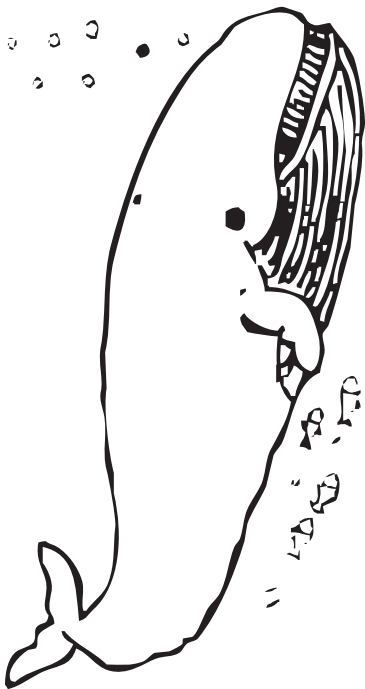
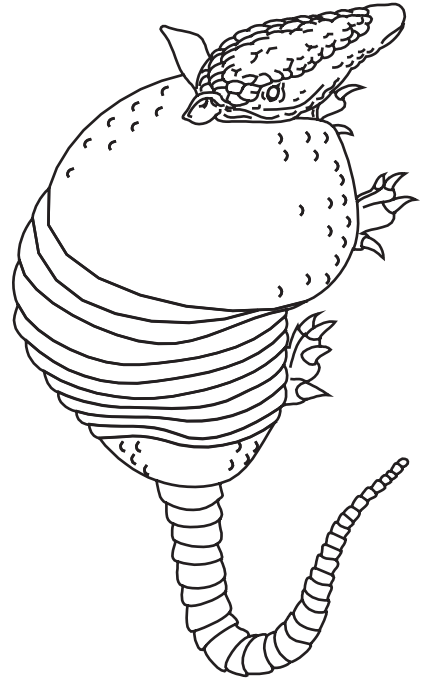
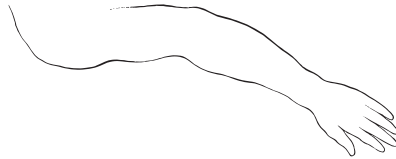

zoológico, brazo, armadillo, ballena, silla de ruedas, silbato



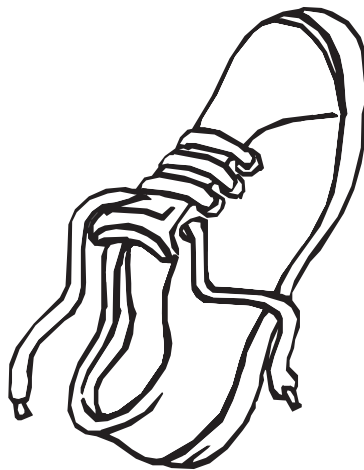
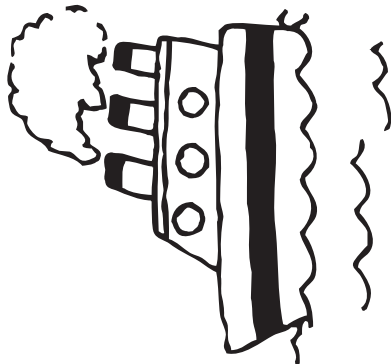
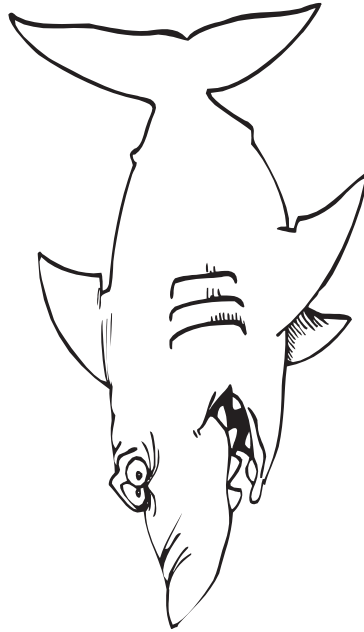
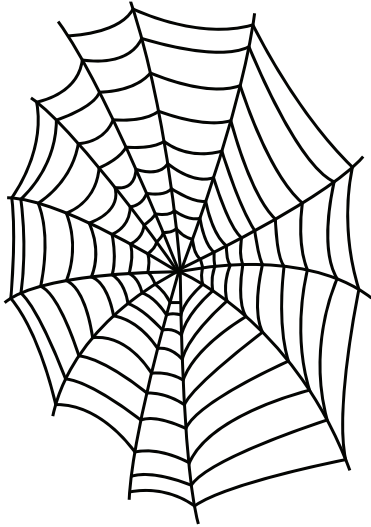

telaraña, tiburón, concha, barco, zapato, termómetro



Fónica

Juego de Memoria del Alfabeto

P.008es

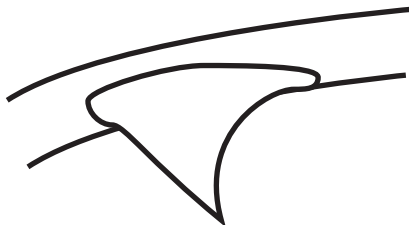
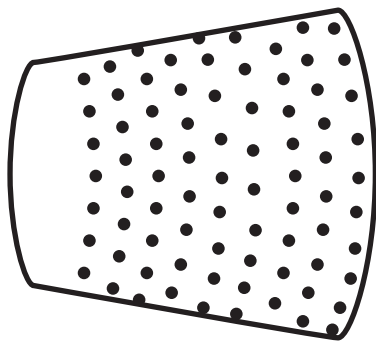

30

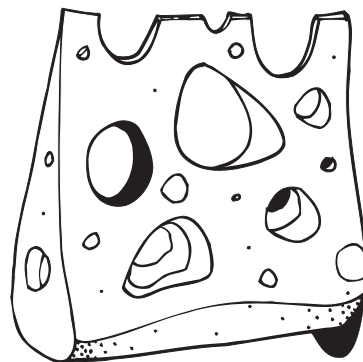
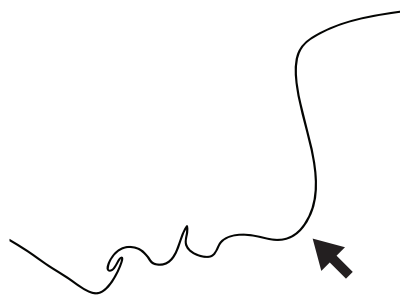
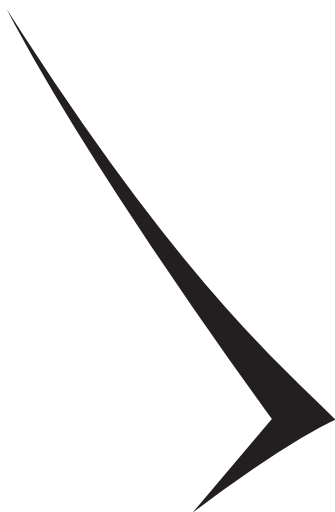

dedal, espina, treinta, comprobar, mentón, queso



P.008es

Juego de Memoria del Alfabeto

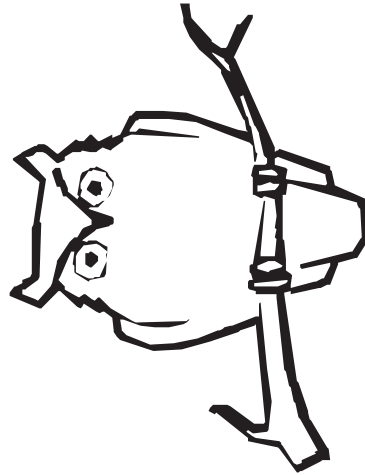
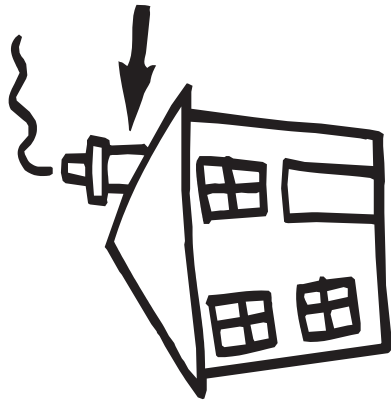

chimenea, búho

